

EJOT®

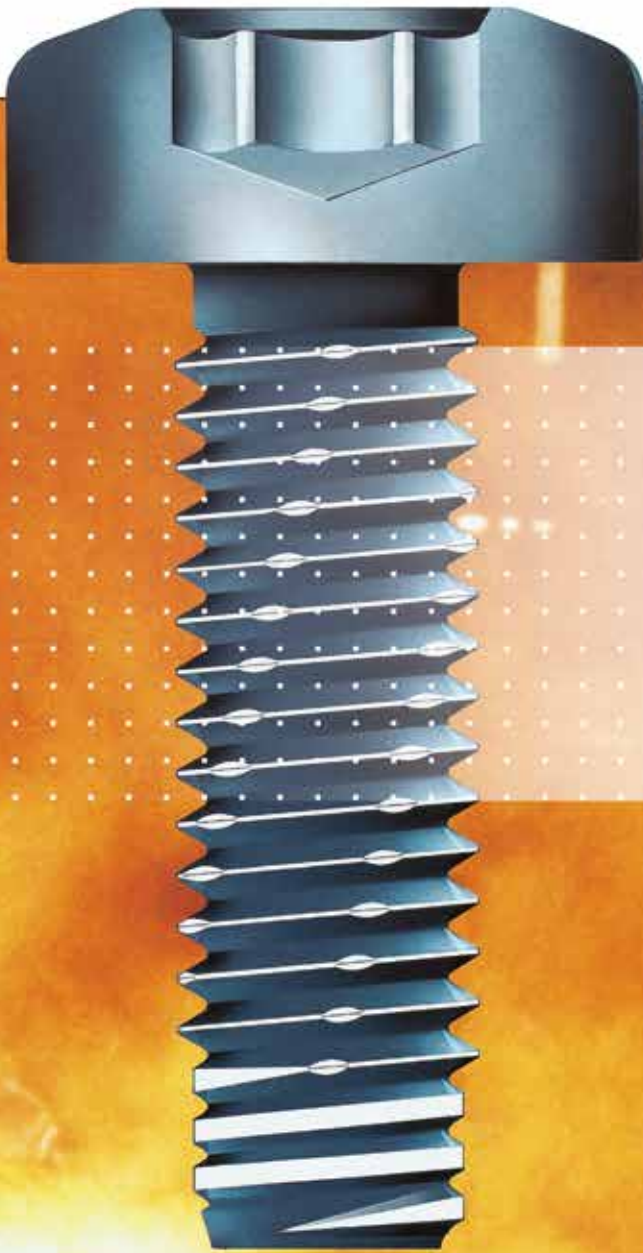

EJOT Spiralform®

The thread formers
for metal

EJOT® The Quality Connection

Imprint

Editor:

EJOT GmbH & Co. KG
Industrial Fasteners Division
D-57319 Bad Berleburg

Layout and Realisation:

EJOT GmbH & Co. KG
Industrial Fasteners Division
D-57319 Bad Berleburg

Print:

© by EJOT GmbH & Co. KG
EJOT®, ALtracs®, EJOMAT®, FDS® and VIBRALOK®
are registered trademarks of EJOT GmbH & Co. KG.
TORX®, TORX PLUS® und AUTOSERT® are registered
trademarks of Acument Intellectual Properties LLCL.
Spiralform® is a registered trademark of
W. Schumacher, Hilchenbach.

All technical data may be subject to technical
improvements.

EJOT Spiralform® screws are special fasteners for safe and problem-free screw fixings into metallic materials, especially steel and stainless steel.

Characteristics:

① **Spiralform® thread**

EJOT Spiralform® screws have four small lobes that are positioned at 90° around the diameter of the screw and run spirally along the length of the thread. The thread that is formed by the lobes corresponds to metric ISO-standard thread DIN 13, tolerance class 6H. This also meets the requirements of VDE.

② **Spiralform® Plus Forming-Point**

The Spiralform® Plus-Point and cylindrical thread is designed to achieve low thread forming torque making the initial thread forming process easier.

③ **Circular Section**

The circular section and small lobes of the Spiralform® thread allow the thread to be formed easily but at the same time ensuring that optimum contact between the screw thread and mating materials is achieved. This results in a consistently high strength process capable joint.

④ **Wide range of materials**

EJOT Spiralform® screws exist in a range of different strengths and materials (see table).



①



②

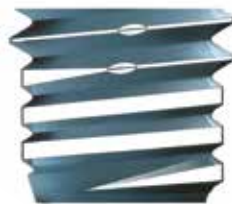

③

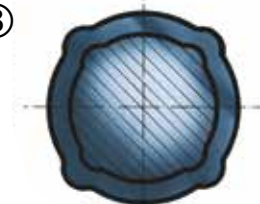

The EJOT Spiralform® product family

The requirements for thread forming screws differ from application to application. Therefore we have developed an EJOT Spiralform® product family which meets the different demands.

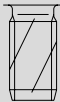
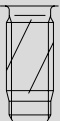
Type	Applications	Versions
Spiralform® Type K 	Steel St 37 to HB 120 (HV 125) the advanced development for low thread forming torques	- case hardened acc. to DIN 7500 DIN EN ISO 7085 respectively (however min. breaking torque and min. tensile strength according EJOT WN 1361 part 1)* surface hardness min. 450 HV
Spiralform® Type Plus 	Steel St 37 to HB 120 (HV 125)	- stainless steel

* In order to minimize risk of hydrogen embrittlement.

Thread design

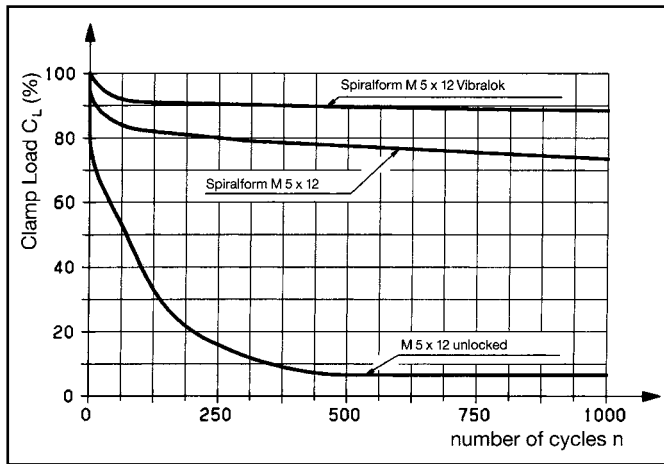

Thread forming - The better technical solution

Thread forming and inserting at once

The result of forming is always an exactly matching, gap-free female thread. This means increased safety against loosening under dynamic stress. Where screw joints need to withstand extreme dynamic or thermal conditions, the combination Spiralform with EJOT VIBRALOK® is recommended (see picture).

The form-fitting thread can take up loads along the whole insertion depth. This means higher strength within the screw joint. The formed and work hardened zone enables higher pull-out forces compared to cut threads.

Problems due to swarf in electrical or pneumatic components resulting from thread cutting of machine threads are now a thing of the past.

The formed female thread of the EJOT Spiralform® screw conforms to metric ISO standard thread according to DIN 13 tolerance field 6H. Metric screws can also be assembled manually afterwards.

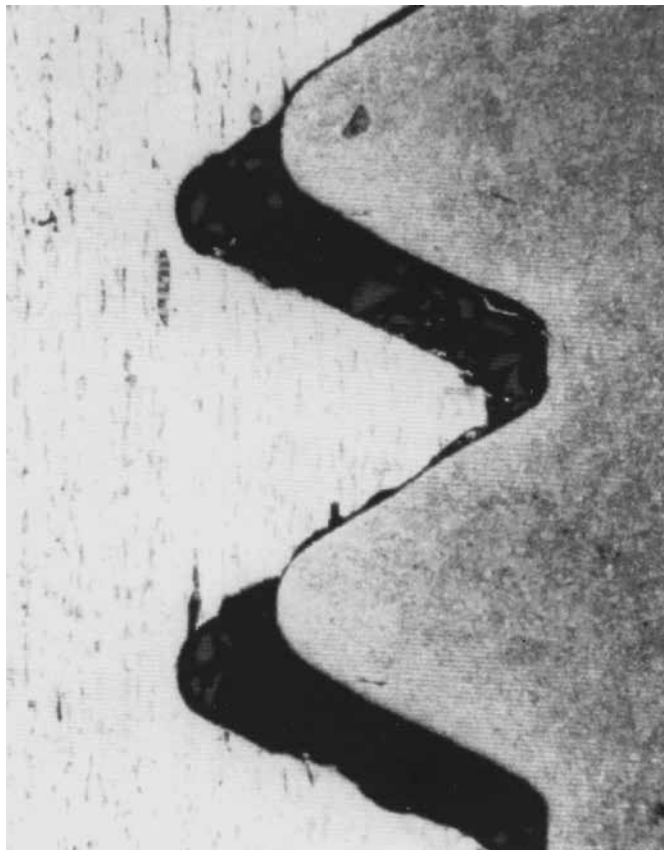

M4 x 16 in a pre-cut thread

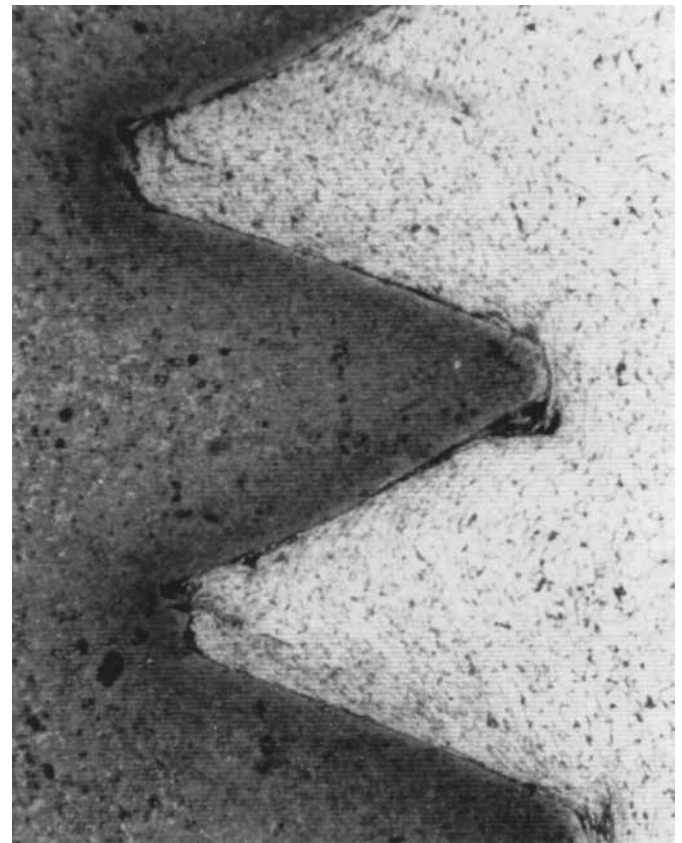

Spiralform® M4 x 16

Thread forming - The better economical solution

Thread Design

The unit cost of a traditional metric fastener makes up only 20% of the overall cost of the total screw joint. The remaining 80% of the cost are made up of the cost of thread cutting, deburring and cleaning operations, consumables such as screw taps and pitch gauges, quality control and any rework and rejected parts, not to mention the cost in time of each of these operations.

Thread forming using the EJOT Spiralfarm® screw on the other hand is far more economical than thread cutting since many of the operations and consumables mentioned above are simply eliminated.

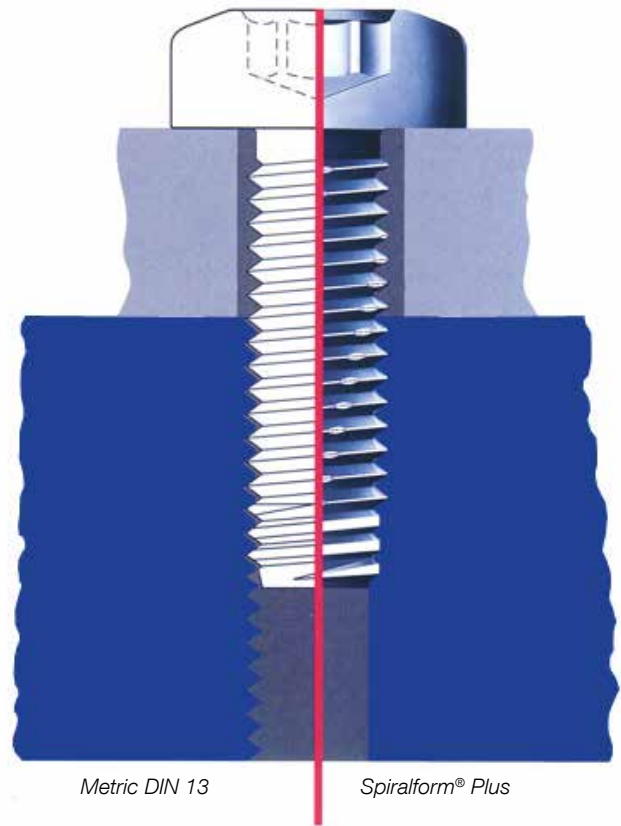

Assembling washer	↑ Assembly costs ↓	●			
Hold up		●	●		
Assembling nut		●	●		
Tapping operation		○	○	●	
Drilling hole		●	●	●	●
Screw installation		●	●	●	●
		→ Unit price →			
		Bolt and nut	Sems-bolt and nut	Bold and nut	EJOT Spiralfarm®

Designs

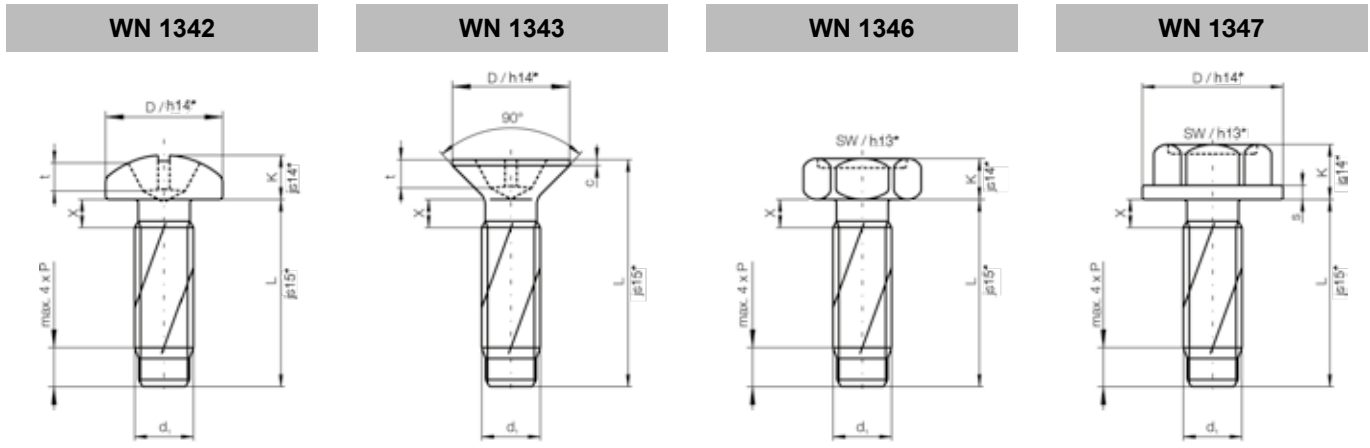

H-cross recess

Z-cross recess

TORX®

TORXplus® /
AUTOSERT®

Type Plus

Type K

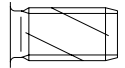
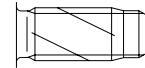

Spiralform®			SF M 2,5	SF M 3	SF M 3,5	SF M 4	SF M 5	SF M 6	SF M 8
External thread-Ø	d ₁		2,50	3,00	3,50	4,00	5,00	6,00	8,00
Thread pitch	P		0,45	0,50	0,60	0,70	0,80	1,00	1,25
Thread run-out	X _{max}		0,90	1,00	1,20	1,40	1,60	2,00	2,50
WN 1342									
Head-Ø	D		5,00	6,00	7,00	8,00	10,00	12,00	16,00
Head height	K		2,00	2,40	2,70	3,10	3,80	4,60	6,00
H-cross-recess penetration depth	t	min.	1,30	1,70	1,74	2,04	2,77	3,03	4,18
		max.	1,60	2,00	2,24	2,54	3,27	3,53	4,68
Z-cross-recess penetration depth	t	min.	1,27	1,68	1,65	1,90	2,64	3,02	4,06
		max.	1,52	1,93	2,11	2,36	3,10	3,48	4,52
Cross size H/Z			1	1	2	2	2	3	4
WN 1343									
Head-Ø	D		4,70	5,60	6,50	7,50	9,20	11,00	14,50
cyl. head height	c _{max}		0,55	0,55	0,55	0,65	0,75	0,85	0,90
H-cross-recess penetration depth	t	min.	1,25	1,50	1,40	1,90	2,10	2,80	3,90
		max.	1,55	1,80	1,90	2,40	2,60	3,30	4,40
Z-cross-recess penetration depth	t	min.	1,22	1,48	1,34	1,60	2,05	2,46	3,86
		max.	1,47	1,73	1,80	2,06	2,51	2,92	4,32
Cross size H/Z			1	1	2	2	2	3	4
WN 1346									
Head height	K		1,70	2,00	2,40	2,80	3,50	4,00	5,30
Width across flats	SW		5,00	5,50	6,00	7,00	8,00	10,00	13,00
WN 1347									
Head-Ø	D				8,00	9,00	11,00	13,00	17,00
Head height	K				3,00	3,40	4,30	5,00	6,60
Width across flats	SW				6,00	7,00	8,00	10,00	13,00
Washer thickness	s ^{+0,2}				0,80	0,80	1,00	1,00	1,00
WN 1321									
Head-Ø	D		6,00	7,50	9,00	10,00	11,50	14,50	19,00
Head height	K		2,10	2,35	2,60	3,05	3,55	4,55	5,90
Washer thickness	s ^{+0,2}		0,50	0,60	0,70	0,90	1,05	1,40	1,80
TORX®	T		T 8	T 10	T 15	T 20	T 25	T 30	T 40
		A _{Ref.}	2,40	2,80	3,35	3,95	4,50	5,60	6,75
Penetration depth	t	min.	0,90	1,00	1,10	1,25	1,60	2,00	2,70
		max.	1,15	1,30	1,40	1,70	2,00	2,40	3,20
TORXplus® / AUTOSERT®	IP		8 IP	10 IP	15 IP	20 IP	25 IP	30 IP	40 IP
		A _{Ref.}	2,40	2,80	3,35	3,95	4,50	5,60	6,75
Penetration depth	t	min.	0,90	1,00	1,10	1,30	1,50	1,90	2,60
		max.	1,15	1,30	1,40	1,65	1,90	2,30	3,10

WN 1321

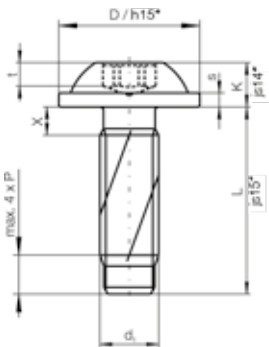

WN 1352

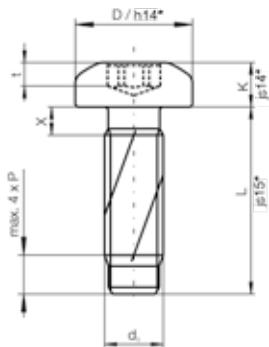

WN 1323

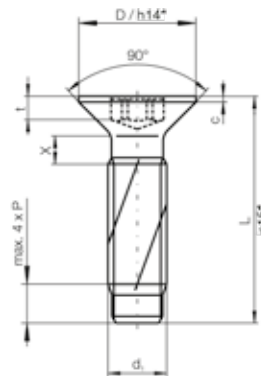

WN 1353

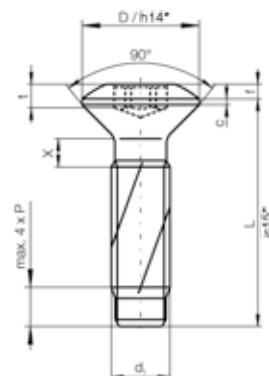

Example of ordering:

Description of EJOT Spiralform® screw with pan head
Z-cross recess, type Plus, Ø 4,0 mm and
length L = 20 mm

* see page 8 tolerance

For more information:

EJOT Hotline
phone +49 2751 529-123
fax +49 2751 529-98 123
e-mail: hotline@ejot.de

EJOT Spiralform® Plus screw WN1342 SF M4 x 20-Z

Spiralform®		SF M 2,5	SF M 3	SF M 3,5	SF M 4	SF M 5	SF M 6	SF M 8	
External thread-Ø	d ₁	2,50	3,00	3,50	4,00	5,00	6,00	8,00	
Thread pitch	P	0,45	0,50	0,60	0,70	0,80	1,00	1,25	
Thread run-out	X _{max}	0,90	1,00	1,20	1,40	1,60	2,00	2,50	
WN 1352	Head-Ø	D	5,00	6,00	7,00	8,00	10,00	12,00	16,00
	Head height	K	2,00	2,40	2,70	3,10	3,80	4,60	6,00
	TORX		T8	T10	T15	T20	T25	T30	T40
		A _{Ref.}	2,40	2,80	3,35	3,95	4,50	5,60	6,75
	Penetration depth	t	min. 0,90	1,00	1,20	1,40	1,60	2,00	2,70
			max. 1,15	1,30	1,50	1,80	2,00	2,40	3,20
	TORXplus® / AUTOSERT®		8IP	10IP	15IP	20IP	25IP	30IP	40IP
		A _{Ref.}	2,40	2,80	3,35	3,95	4,50	5,60	6,75
	Penetration depth	t	min. 0,90	1,10	1,10	1,50	1,75	2,20	2,60
			max. 1,10	1,30	1,40	1,80	2,10	2,60	3,10
WN 1323	Head-Ø	D	4,70	5,50	7,30	8,40	9,30	11,30	15,80
	cyl. head height	c _{max}	0,55	0,55	0,65	0,70	0,75	0,85	0,95
	TORX		T8	T10	T15	T20	T25	T30	T40
		A _{Ref.}	2,40	2,80	3,35	3,95	4,50	5,60	6,75
	Penetration depth	t	min. 0,70	0,75	0,85	1,10	1,15	1,40	1,75
			max. 0,90	1,10	1,15	1,55	1,55	1,80	2,25
	TORXplus® / AUTOSERT®		8IP	10IP	15IP	20IP	25IP	30IP	40IP
		A _{Ref.}	2,40	2,80	3,35	3,95	4,50	5,60	6,75
	Penetration depth	t	min. 0,70	0,75	0,90	1,10	1,25	1,55	1,85
			max. 0,90	1,05	1,20	1,45	1,60	2,00	2,40
WN 1353	Head-Ø	D	4,70	5,60	6,50	7,50	9,20	11,00	14,50
	cyl. head height	c _{max}	0,55	0,55	0,55	0,65	0,75	0,85	0,90
	Calotte height	≈f	0,60	0,75	0,90	1,00	1,25	1,00	2,00
	TORX		T8	T10	T15	T20	T25	T30	T40
		A _{Ref.}	2,40	2,80	3,35	3,95	4,50	5,60	6,75
	Penetration depth	t	min. 0,90	1,00	1,20	1,40	1,60	2,00	2,70
			max. 1,15	1,30	1,50	1,80	2,00	2,40	3,20
	TORXplus® / AUTOSERT®		8IP	10IP	15IP	20IP	25IP	30IP	40IP
		A _{Ref.}	2,40	2,80	3,35	3,95	4,50	5,60	6,75
	Penetration depth	t	min. 0,90	1,10	1,10	1,50	1,50	1,90	2,60
			max. 1,10	1,30	1,40	1,80	1,85	2,30	3,10

Designs

Material:

Case hardened steel
Stainless steel A2

Chrom VI free platings:

- zinc clear / blue passivated
- zinc clear / blue passivated + EJOSEAL (240h resistance to Zn-corrosion)
- zinc / thick film passivation
- ZnFe or ZnNi / transparent passivated (with or without black top coats)
- ZnNi / black passivated
- Zinc flake coatings (example Delta Protekt)
- lubrication

Different materials and platings are available on request.

Special variations / Examples

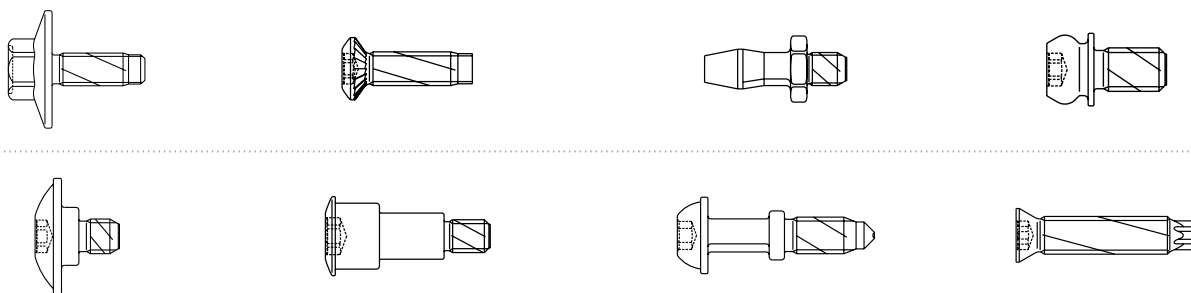

Special variations are available, for example:
under head profiles, captive washers, undetachable assembled washers, combination cross recess, combination-TORX®

Please contact the EJOT application engineers to achieve your multifunctional designs.

Tolerance ranges of EJOT Spiralform® screws

Tolerance	Nominal value [mm]					
		over 3	over 6	over 10	over 18	over 30
	to 3	to 6	to 10	to 18	to 30	to 50
h 13	0 -0,14	0 -0,18	0 -0,22	0 -0,27		
h 14	0 -0,25	0 -0,30	0 -0,36	0 -0,43	0 -0,52	
h 15	0 -0,40	0 -0,48	0 -0,58	0 -0,70	0 -0,84	
js 14	± 0,12	± 0,15	± 0,18			
js 15	± 0,20	± 0,24	± 0,29	± 0,35	± 0,42	± 0,50

Manufacturing range of EJOT Spiralform® screws

EJOT® Spiralform	M2,5	M3	M3,5	M4	M5	M6	M8	M10
d ₁ [mm]	2,5	3,0	3,5	4,0	5,0	6,0	8,0	10,0
Length L [mm]								
5,0 ± 0,24	Grey	Blue						
6,0 ± 0,24	Grey	Grey	Blue	Blue				
7,0 ± 0,29	Grey	Grey	Grey	Blue				
8,0 ± 0,29	Grey	Grey	Grey	Grey	Blue			
10,0 ± 0,29	Grey	Grey	Grey	Grey	Grey	Blue		
12,0 ± 0,35	Grey	Grey	Grey	Grey	Grey	Grey	Blue	
14,0 ± 0,35	Grey	Grey	Grey	Grey	Grey	Grey	Blue	
16,0 ± 0,35	Grey	Grey	Grey	Grey	Grey	Grey	Grey	Blue
18,0 ± 0,35	Grey	Grey	Grey	Grey	Grey	Grey	Grey	Blue
20,0 ± 0,42	Grey	Grey	Grey	Grey	Grey	Grey	Grey	Grey
22,0 ± 0,42	Grey	Grey	Grey	Grey	Grey	Grey	Grey	Grey
25,0 ± 0,42	Grey	Grey	Grey	Grey	Grey	Grey	Grey	Grey
30,0 ± 0,42	White (dashed)	White (dashed)	Grey	Grey	Grey	Grey	Grey	Grey
35,0 ± 0,50	White (dashed)	White (dashed)	White (dashed)	Grey	Grey	Grey	Grey	Grey
40,0 ± 0,50	White (dashed)	White (dashed)	White (dashed)	White (dashed)	Grey	Grey	Grey	Grey
50,0 ± 0,50	White (dashed)	White (dashed)	White (dashed)	White (dashed)	White (dashed)	Grey	Grey	Grey
60,0 ± 0,60	White (dashed)	White (dashed)	White (dashed)	White (dashed)	White (dashed)	White (dashed)	Grey	Grey
70,0 ± 0,60	White (dashed)	White (dashed)	White (dashed)	White (dashed)	White (dashed)	White (dashed)	White (dashed)	Grey
80,0 ± 0,60	White (dashed)	White (dashed)	White (dashed)	White (dashed)	White (dashed)	White (dashed)	White (dashed)	Grey
90,0 ± 0,70	White (dashed)	White (dashed)	White (dashed)	White (dashed)	White (dashed)	White (dashed)	White (dashed)	White (dashed)
100,0 ± 0,70	White (dashed)	White (dashed)	White (dashed)	White (dashed)	White (dashed)	White (dashed)	White (dashed)	White (dashed)

Special length upon request!

— upper line ≙ minimal length
 (countersunk head length $L_{min} = L + 0,6 \times d_1$)

- - - lower line ≙ maximal length

 Thread end type K

 Thread end type Plus

 Production only with partial thread possible!
 (partial thread length $4 \times d_1$)

EJOT Spiralform®

Design recommendations

The level of installation torque depends on several parameters. The most important ones of them are type of material and its strength, required insertion depth (material thickness), kind of surface treatment for screw and work material, potential lubricants and the used pre-hole diameter. Below you will find general recommendations in terms of quality for sheet and steel. For the precise design of your application we offer the service of our state of the art EJOT APPLITEC laboratory. For more details please contact your responsible application engineer or the EJOT Hotline.

When using the EJOT Spiralform® Plus thread geometry, please ensure sufficient insertion depth for blind holes in particular. The screw point „Plus“ reduces the number of fully load carrying threads by about four (see table opposite). Spiralform® Plus should be used where sufficient insertion depth and hole clearance are available.

For applications in light weight alloys and die cast materials we advise using the EJOT ALtracs® Plus screw.

For thin sheet metals with a thickness of 0,4 mm to 1,0 mm the EJOT SHEETtracs® fastener is recommended.

In order to enable plane bearing surfaces for the clamped components, please chamfer the top of the pre hole. This design step also improves the start of the insertion process.

Nominal-Ø	2,5	3,0	3,5	4,0	5,0	6,0	8,0
length of the forming point (max. 4 x P)	1,8	2,0	2,4	2,8	3,2	4,0	5,0

P = pitch

This applies only for the forming point type Plus.

Hole dimensioning for sheet metal through drafts

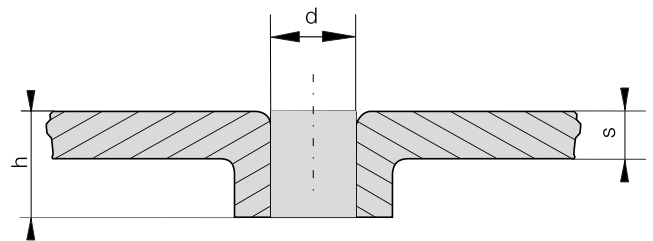

Core hole diameter for sheet metal through drafts in steel HB 110 - 130								
Nominal thread diameter	M 2,5	M 3	M 3,5	M 4	M 5	M 6	M 8	M 10
Core hole diameter d [mm]	2,25 2,31	2,70 2,76	3,15 3,23	3,60 3,68	4,50 4,58	5,40 5,47	7,30 7,39	9,15 9,25
Through draught depth	$h = (1,5 - 2) s$							

Hole dimensioning for sheet metals

In case of punched holes the punching direction should correspond to the installation direction.

Design recommendations

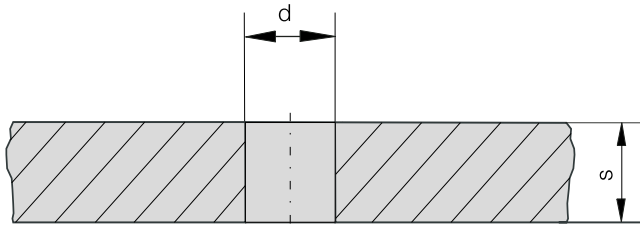

Core hole diameter for drilled and punched holes in steel ¹⁾

Material	Sheet metal thickness or installation length s [mm]	Nominal thread diameter							
		M 2,5	M 3	M 3,5	M 4	M 5	M 6	M 8	M 10
Steel 110 - 130 HB	over 0,5 - 1,5 ²⁾	2,26	2,71	3,175	3,625	-	-	-	-
		2,20	2,65	3,10	3,55	-	-	-	-
	over 1,5 - 2,5	2,26	2,76	3,175	3,625	4,575	5,475	-	-
		2,20	2,70	3,10	3,55	4,50	5,40	-	-
	over 2,5 - 4,0	2,31	2,76	3,225	3,675	4,625	5,525	7,34	9,20
		2,25	2,70	3,15	3,60	4,55	5,45	7,25	9,05
	over 4,0 - 6,3	2,36	2,81	3,225	3,725	4,675	5,575	7,44	9,30
		2,30	2,75	3,15	3,65	4,60	5,50	7,35	9,15
	over 6,3 - 10,0	-	2,81	3,275	3,775	4,725	5,625	7,54	9,45
		-	2,75	3,20	3,70	4,65	5,55	7,45	9,30
	over 10,0	-	-	-	-	-	5,675	7,59	9,50
		-	-	-	-	-	5,60	7,50	9,35

1) For screw joints in light weight alloys (Aluminium, Magnesium, and Zinc die-cast) we recommend EJOT ALtracs® Plus screws.

2) For thin sheet metals with a thickness of 0,4 mm to 1,0 mm the EJOT FDS® or the EJOT SHEETtracs® screws is recommended.

For other materials please contact:

EJOT Hotline

phone +49 2751 529-123

fax +49 2751 529-98 123

e-mail: hotline@ejot.de

EJOT Spiralform®

Notes for assembly

The thread forming torque is influenced by the following:

- External screw diameter
- Surface condition of screw and component
- Material of the component
- Core hole diameter

EJOT Spiralform® screws with plating thickness of 8µm zinc and lubrication comply with the permissible thread forming torque according to DIN 7500 or DIN EN ISO 7085 respectively relative to the test conditions stated in each standard. In the event of greater plating thicknesses, test conditions should be adjusted according to the needs of the respective application. Further mechanical properties are shown in the table below.

EJOT Spiralform® screws can be assembled by means of electrical and pneumatic tools and also automatically fed. We recommend common screw drivers with an adjustable torque limiting clutch.

Analysis of measuring process

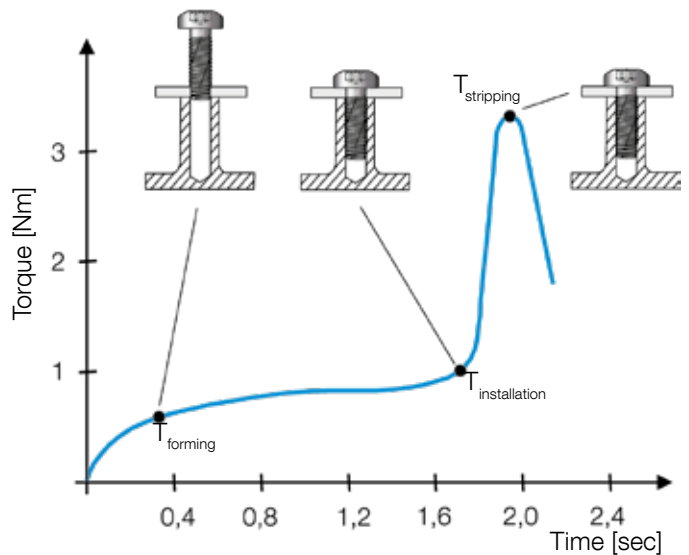
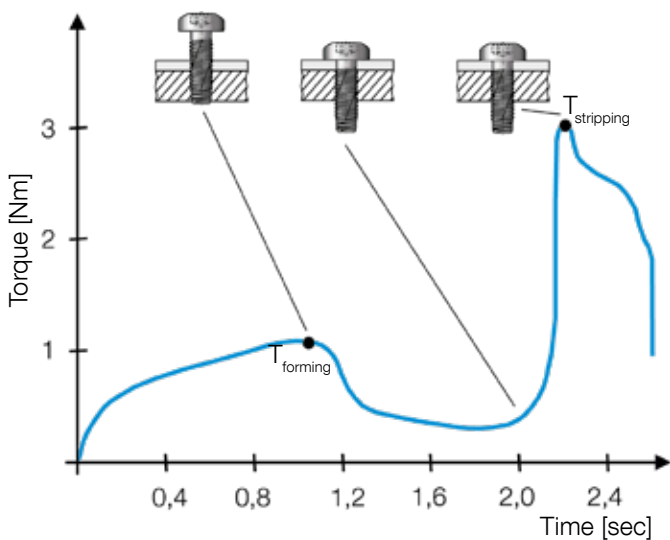

Specification	Nominal thread diameter						
	M2,5	M3	M3,5	M4	M5	M6	M8
External diameter max. [mm]	2,48	2,98	3,48	3,98	4,98	5,97	7,97
Drilling hole diameter of working part [mm]	2,58	3,10	3,61	4,12	5,12	6,12	8,12
Thickness of working part acc. DIN EN ISO 7085 [mm]	2,50	3,00	3,50	4,00	5,00	6,00	8,00
Forming torque acc. DIN EN ISO 7085 max. [mm]	0,60	1,00	1,60	2,40	4,70	8,00	20,00
Min. breaking torque acc. EJOT WN1361 T1 [Nm]	1,00	1,50	2,30	3,40	7,10	12,00	29,00
Min. tensile breaking load acc. EJOT WN1361 T1 [N]	2.700	4.000	5.400	7.000	11.400	16.000	29.000



Your system partner*Test rack at EJOT® APPLITEC**Internal seminar***Design Consultation**

A major consideration of today's product manufacture is the basic need to be cost competitive. Significant in achieving this objective is the design process. No other part of the cost structure is influenced more than by design.

Generally speaking, the development of a product, which represents about 10% of the overall costs, determines about 70% of the costs for the final product.

Often the design of the fixing is considered to be of low importance; however, it is the fastener that holds the components together to make the finished product. With this in mind the design engineer should consider which fastening method to use during the design conception stage to avoid expensive design changes late on in the design process or even when the product goes into production.

To assist our customers in this process EJOT offers support during the design stage through comprehensive application engineering services. These services provide accurate information on product performance and result in design recommendations that can be used safely on the production line.

Consequent Application Engineering

By continuously working with our customers and their application problems, EJOT has amassed a comprehensive understanding of fastener techniques that has led to a number of significant innovations. It is our goal to continually improve our products to meet the ever increasing demands of our customers.

In addition to our highly qualified engineers and application-engineering advisers, we offer the service of our application laboratory known as the EJOT® APPLITEC. In the APPLITEC we carry out test procedures on our customer's applications that enables us to thoroughly analyse the strength and capability of their parts. It is here that new fastening techniques are also developed.

The knowledge EJOT has gained over the years is passed on to our customers finding the most effective solution supporting their efforts in establishing rational fastening and assembly techniques. Detailed test reports, on site technical advice, acknowledged seminars and technical publications demonstrate our continued commitment to impart our knowledge.

*Test report*

Logistic and Data Exchange

It is our aim to keep procurement and warehousing costs as low as possible by simultaneously offering product availability and quality.

With respect to simplified procuring processes, EJOT offers a variety of cost reducing procedures and services. The continued analysis of our customer's demands and advanced logistics procedures are leading to high availability of our products. Skeleton contracts and delivery schedules via electronic data interchange facilitate and accelerate the processing times of our products.

Quality for Automated Assembly

The fasteners' grade of purity has a significant impact on the minimisation of failure and thus leads to a high availability of the assembly machine. Historically, the standard quality in commercial fastener manufacture was not sufficient for today's high quality requirements since originally it had been designed for mainly manual assembly.

EJOT introduced the EJOMAT® Quality to ensure the most cost-effective usage of our customers' automated assembly machines.

The grade of purity offered by EJOMAT® quality is 10 times higher than the usual standard quality which means increased availability of assembly machine and decreased assembly down time costs.

EJOMAT®, quality that pays for itself.

EJOT Sales Organization

In addition to EJOT companies throughout Europe a growing number of Licensees in North & South America and Asia ensures that product availability and local support is Global.

Contact details can be found on our Homepage www.ejot.com.



Modern PPS-systems lead to high accuracy in supplying and short through put times



EJOMAT® for fully automated assembly



EJOT GmbH & Co. KG

Industrial Fasteners Division

Im Herrengarten 1

57319 Bad Berleburg - GERMANY

P.O. Box 10 12 60

57302 Bad Berleburg - GERMANY

phone +49 2751 529-0

fax +49 2751 529-559

e-mail: industrie@ejot.de

Internet: www.industrie.ejot.com